

**Datasheet**

Subject to technical alteration  
Issue date: 18.05.2018 • A003

**Application**

Duct averaging temperature sensor in enclosure USE-S for measuring the average temperature in air ducts. The sensor detects the applied temperature value throughout the entire length. Mounting angles for uncomplicated duct mounting are included in delivery. A spring at the connection head reduces vibrations.

**Types Available****Duct averaging sensor temperature – passive**

MWF+ <Sensor> L<x> incl. installation kit

**Duct averaging sensor temperature – active TRV 0..10 V | TRA 4..20 mA**

MWF+ TRV MultiRange L<x> incl. Installation kit

MWF+ TRA MultiRange L<x> incl. Installation kit

<x>: sensor rod length 3000/6000 mm

<sensor>: Pt1000/Ni1000/Ni891/Ni1000TK5000

MultiRange: Measuring ranges adjustable at the transducer

## Security Advice – Caution



The installation and assembly of electrical equipment should only be performed by authorized personnel.

The product should only be used for the intended application. Unauthorised modifications are prohibited! The product must not be used in relation with any equipment that in case of a failure may threaten, directly or indirectly, human health or life or result in danger to human beings, animals or assets. Ensure all power is disconnected before installing. Do not connect to live/operating equipment.

Please comply with

- Local laws, health & safety regulations, technical standards and regulations
- Condition of the device at the time of installation, to ensure safe installation
- This data sheet and installation manual

## Notes on Disposal



As a component of a large-scale fixed installation, Thermokon products are intended to be used permanently as part of a building or a structure at a pre-defined and dedicated location, hence the Waste Electrical and Electronic Act (WEEE) is not applicable. However, most of the products may contain valuable materials that should be recycled and not disposed of as domestic waste. Please note the relevant regulations for local disposal.

## General remarks concerning to sensors

Especially with regard to passive sensors in 2-wire conductor versions, the wire resistance of the supply wire has to be considered. If necessary the wire resistance has to be compensated by the follow-up electronics. Due to self-heating, the wire current affects the measurement accuracy. So it should not exceed 1 mA.

When using lengthy connection wires (depending on the cross section used) the measuring result might be falsified due to a voltage drop at the common GND-wire (caused by the voltage current and the line resistance). In this case, 2 GND-wires must be wired to the sensor - one for supply voltage and one for the measuring current.

Sensing devices with transducer should always be operated in the middle of the measuring range to avoid deviations at the measuring end points. The ambient temperature of the transducer electronics should be kept constant. The transducers must be operated at a constant supply voltage ( $\pm 0,2$  V). When switching the supply voltage on/off, onsite power surges must be avoided.

## Build-up of Self-Heating by Electrical Dissipative Power

Temperature sensors with electronic components always have a dissipative power, which affects the temperature measurement of the ambient air. The dissipation in active temperature sensors shows a linear increase with rising operating voltage. This dissipative power has to be considered when measuring temperature. In case of a fixed operating voltage ( $\pm 0,2$  V) this is normally done by adding or reducing a constant offset value. As Thermokon transducers work with a variable operating voltage, only one operating voltage can be taken into consideration, for reasons of production engineering. Transducers 0..10 V / 4..20 mA have a standard setting at an operating voltage of 24 V =. That means, that at this voltage, the expected measuring error of the output signal will be the least. For other operating voltages, the offset error will be increased by a changing power loss of the sensor electronics. If a re-calibration should become necessary later directly on the sensor, this can be done by means of a trimming potentiometer on the sensor board.

**Remark: Occurring draft leads to a better carrying-off of dissipative power at the sensor. Thus temporally limited fluctuations might occur upon temperature measurement.**

## Technical Data

<b>Measuring values</b>	temperature		
<b>Output voltage</b> (type-dependent)	<b>TRV</b> 1x 0..10 V or 0..5 V, min. load 5 kΩ		
<b>Output ampere</b> (type-dependent)	<b>TRA</b> 1x 4..20 mA, max. load 500 Ω		
<b>Output passive</b> (type-dependent)e	<b>passive</b> optional, PT1000/Ni1000/Ni891/Ni1000TK5000		
<b>Power supply</b> (type-dependent)	<b>TRV</b> 15..24 V = (±10%) or 24 V ~ (±10%) SELV	<b>TRA</b> 15..24 V = (±10%) SELV	
<b>Power consumption</b> (type-dependent)	<b>TRV</b> typ. 0,4 W (24 V =)   0,8 VA (24 V ~)	<b>TRA</b> typ. 0,5 W (24 V =)	
<b>Measuring range temp.</b> (type-dependent)	<b>passive</b> -50..+80 °C, depending on used sensor		
<b>Output signal range temp.</b> *Scaling analogue output (type-dependent)	<b>TRV   TRA</b> default setting: -20..+80 °C selectable from 8 temperature ranges -50..+50   -20..+80   -15..+35   -10..+120   0..+50   0..+100   0..+160   0..+250 °C, adjustable at the transducer		
<b>Operating temperature range</b> * Max. permissible operating temperature	<b>sensor rod</b> -50..+80 °C	<b>electronic   enclosure</b> -35..+70 °C	<b>mounting base</b> -35..+90 °C
<b>Accuracy temperature</b> (type-dependent)	<b>TRV   TRA</b> ±0,5 K (typ. at 21 °C within default measuring range)	<b>passive</b> Pt1000: DIN class B Ni1000/Ni891/Ni1000TK5000: ±0,4 K (typ. at 32 °F)	
<b>Enclosure</b>	enclosure USE-S, PC, pure white, with removable cable entry		
<b>Protection</b>	IP65 according to EN 60529		
<b>Cable entry</b>	Flextherm M16, for wire Ø=3.7 mm, removable		
<b>Connection electrical</b>	removable plug-in terminal, max. 2,5 mm²		
<b>Sensor rod</b> (optional)	3000 mm, 6000 mm (optional)		
<b>Ambient condition</b>	max. 85% rH short term condensation		

## Mounting Advices

Model MWF can either be mounted directly on the ventilation duct by means of a mounting flange or by screws.

By means of the mounting brackets included the sensor rod is braced to the ventilation duct.

**Note: Please pay attention to the sensor rod while mounting and protect it from mechanical damage!**

**Mounting angle:**

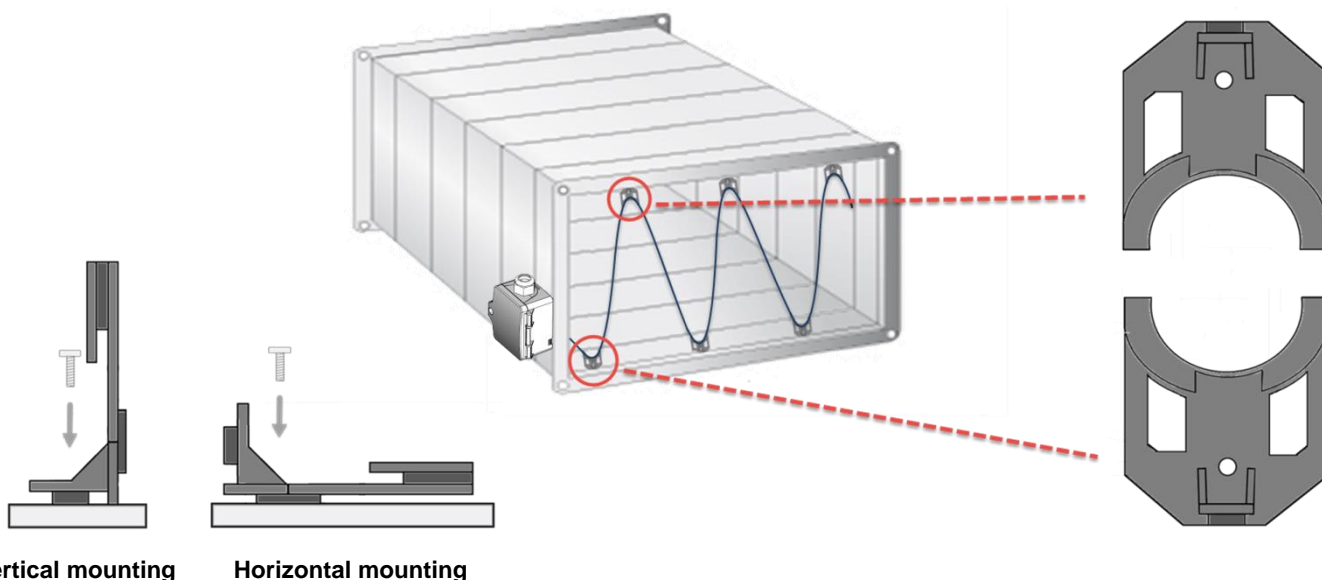

Vertical mounting

Horizontal mounting

## Connection Plan and Configuration

The adjustment of the measuring ranges is made by changing the jumpers in a de-energized state. The output value of the new measuring range is available after 2 seconds.

TRA:  
4..20 mA

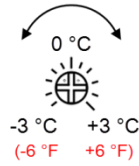
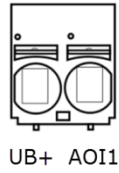
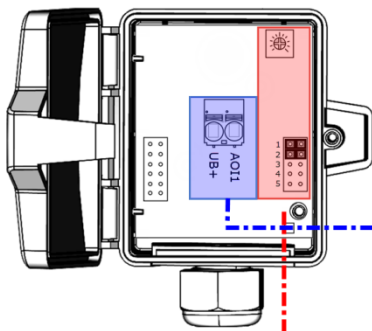

TRV:  
0..10 V | 0..5 V

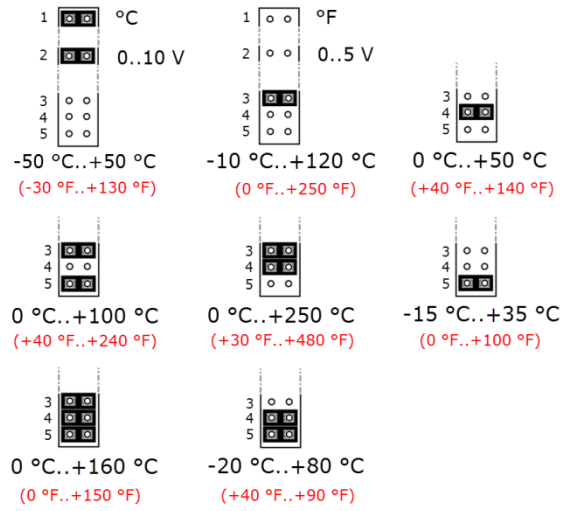
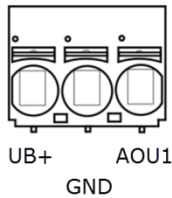
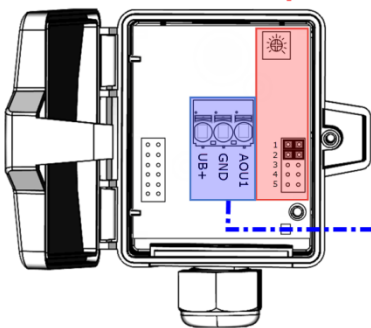

fig. (Measuring range and offset adjustment, default settings: -20 °C..+80 °C | 0 K)

Passiv

(Pt1000 | Ni1000 | Ni891 | Ni1000TK5000)

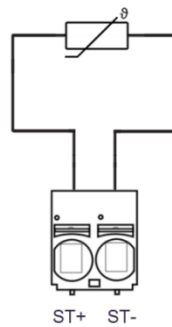
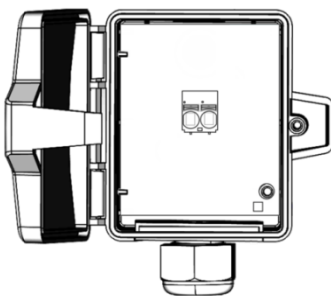
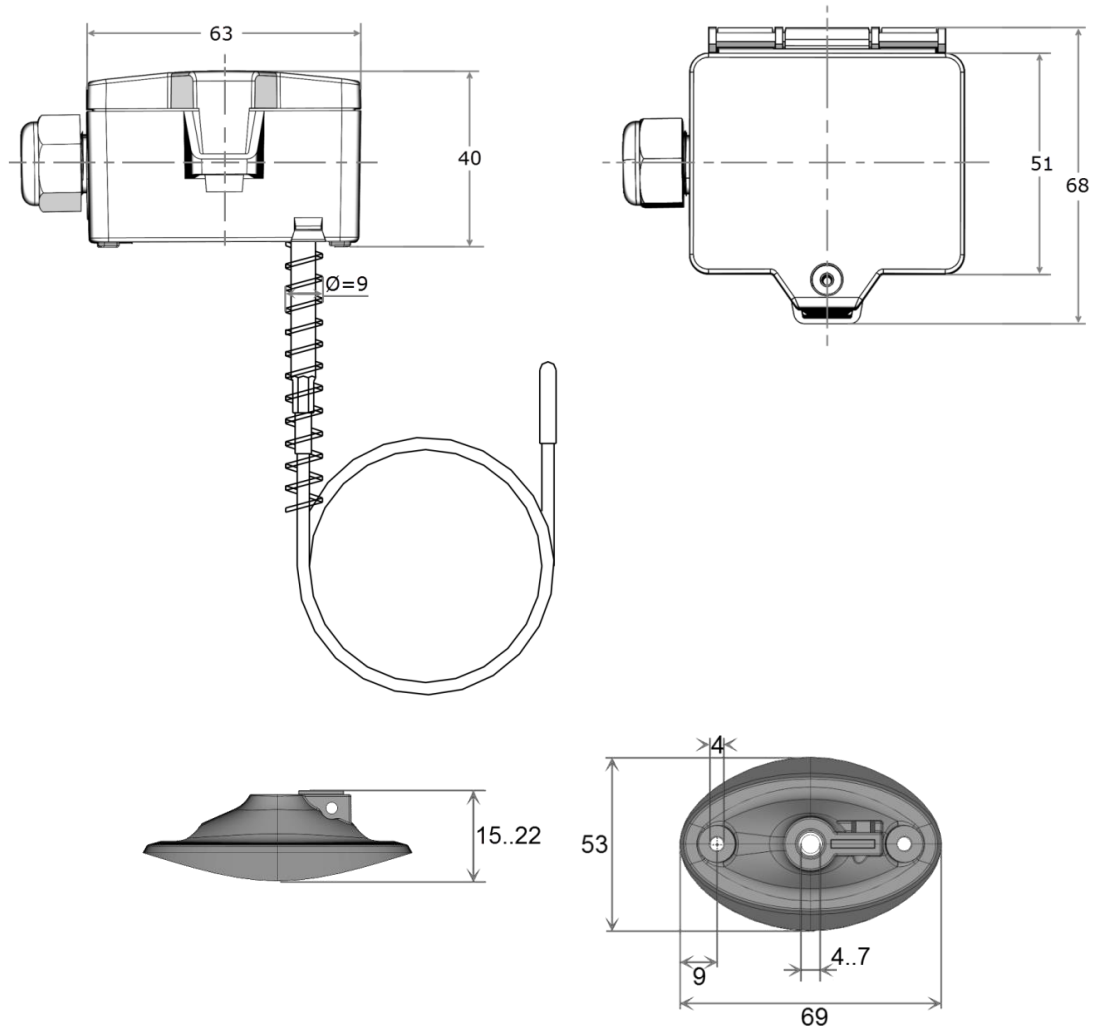

fig. (terminal assignment passive sensor)

## Dimensions (mm)



## Accessories (included in delivery)

Mounting flange MF6 flexible (incl. inserts for  $\varnothing=4$  | 6 | 7 mm)  
 Mounting angle set  
 Mounting kit universal  
 • Cover screw + screw cover • 2 Rawlplugs • 2 Screws (countersunk head) • 2 Screws (rounded head)

Item No. 399098  
 Item No. 458399  
 Item No. 698511

## Accessories (optional)

Mounting base enclosure USE pure white  
 Mounting flange MF7 (brass)  
 M16 Sealing inserts cable entry (packaging unit 10 pcs.) for wire with  $\varnothing$  8 mm

Item No. 667722  
 Item No. 102360  
 Item No. 641340